

Using Simulation Modeling to Create Transdisciplinary Process Models and to Build Basic PLM Tools to Support the Systems Engineering Lifecycle

Germano de Souza Kienbaum

Laboratory for Applied Mathematics and Computing
National Space Research Institute (INPE)
São José dos Campos, Brasil
e-mail: kienbaum@lac.inpe.br

Álvaro Augusto Neto

Science Computer Division
Aeronautics Institute of Technology
São José dos Campos, Brasil
e-mail: alvaro@ita.br

Renato Fernandez

Federal Institute for Education, Science and
Technology (IFSP)
São Paulo, Brasil
e-mail: renato@ifsp.edu.br

Elaino Kelson Teixeira Silva

BPMExpert Engenharia de Sistemas LTDA
São José Campos, Brasil
e-mail: kelson@jetsoft.com.br

Abstract - This work describes the use of simulation modeling methodology to create transdisciplinary reference process models, which can then be transformed into specialised models, making use of the methodologies originated from traditional autonomous disciplines that deal with complex discrete event process problems, namely: Systems (Concurrent) Engineering, Project Management, Business Process Management and Simulation Modeling. In particular, the transformation of the enterprise's systems (concurrent) engineering process lifecycle (an aggregate of product engineering and organization's management processes) into specialised models and their implementation, making use of the appropriate inherent methodology and tools originated from these traditional autonomous study areas, result in integrated applications that can be used as tools to support basic Product Lifecycle Management. These tools can be used to support the execution of essential procedures in the Small and Medium Enterprise's systems (concurrent) engineering process, as an alternative to complete and/or tailored Product Lifecycle Management and Business Process Management support systems, which are usually costly, complex, difficult to customize and to integrate with other legacy software applications, and therefore not suitable for use by Small and Medium Enterprises.

Keywords - Systems Engineering; Project Management; Business Process Management; Simulation Modeling; Transdisciplinary Process Science and Technology

I. INTRODUCTION

Transdisciplinary Process Science and Technology (T-ProST) is a term used in this work to designate a holistic view, which consists of the integration of various disciplines that deal with complex discrete event process models: Systems (Concurrent) Engineering (SE) [3][9][13], Project Management (PM) [18], Business Process Management (BPM) [10][14] and Simulation Modeling (SIM) [15]. T-ProST strives towards improving the modeling and seeking better and integrated engineering and management solutions for complex discrete event problems.

The general goal of the research endeavors on T-ProST has a wide scope and very ambitious nature: to develop a mature and comprehensive transdisciplinary process modeling methodology (T-ProST Framework) and to design and implement its integrated supporting environment for application to a large category of complex discrete event process problems. The problem domain covered by T-ProST is essentially the same one covered by discrete event process modeling and simulation procedures based on modeling representations, such as Activity Cycle Diagrams (ACD) [15], Role Activity Diagrams (RAD) [11] and Workflow Diagrams (Workflows) [19].

The main difference and original contribution between the use of the T-ProST Framework and that of the traditional use of its component disciplines is the creation of a transdisciplinary process model and its use as a common basis for the development of their individual specialised process models. This is done by conducting a systematic modeling procedure designated as Conceptual or Reference Modeling and making use of a graphical notation denominated Unified Lifecycle Modeling Diagrams (ULMD), an innovative diagramming technique originated from a fusion of the aforementioned graphical representations [7][8][12].

This work presents the T-ProST approach as a totally integrated application of their component individual autonomous disciplines and their supporting tools to the design phase of the SE lifecycle. The case study performed and explained here is original and it targets the application of the T-ProST Framework to the Small and Medium Enterprise's (SME) SE lifecycle and SME's BPM lifecycle. These denominations refer to the complete systems engineering lifecycle and the SME's business process management lifecycle, respectively, which include, but is not limited to, its product engineering and production management processes.

The limitation of the scope to the design phase of the SE lifecycle in order to explain the T-ProST approach was made for demonstration purpose only. In fact, it can be applied to

any category of complex discrete event process that can be dealt with the ULMD notation and it is intended to be scalable and capable of being used in a wider context, covering the whole organization’s business process management, be it a SME or normal enterprise.

The reason why one targets SME rather than a broader spectrum is that this segment could benefit the most from the methodology and tools proposed in the T-ProST approach. These enterprises can make use of the software environment created with the T-ProST Framework as an alternative to complete and/or tailored Product Lifecycle Model (PLM) and BPM support systems, which are costly, complex, difficult to customize and to integrate with other legacy software applications, and therefore not suitable for use by SME to support their SE lifecycle.

The rest of this work is structured according to the following. Section II defines some fundamentals concepts of the methodology. Section III describes the T-ProST approach. Section IV identifies the problem and sets the overall scope of the research. Section V presents the conceptual modeling phase and the resulting reference model. Section VI describes the specialised model building and analysis phases, for each of the four disciplines comprised by T-ProST (SE, PM, BPM and SIM). Section VII performs a global assessment on the integrated results obtained from the application of the individual disciplines and their supporting tools. Some issues considered are T-ProST’s domain of applicability and the benefits and limitations of the methodology. Finally, in Section VIII, the Holistic Revision and Conclusions presents a summary of the experience gained (the “lessons learned”) with the development of the T-ProST approach and the application of the T-ProST Framework in some case studies already conducted with the methodology.

II. FUNDAMENTALS OF THE METHODOLOGY

The most fundamental and distinctive concepts in T-ProST are those of the transdisciplinary reference process model and its specific notation, denominated Unified Lifecycle Modeling Diagrams (ULMD), as created by the first author [7][8][12]. The reference process model in ULMD describes the system’s lifecycle process in its essential structural and dynamical features, with the special purpose of serving as a common basis for the development of the additional specialised unidisciplinary models to be implemented in each of the autonomous component disciplines of T-ProST.

The actual ULMD designation and its notation format is an evolution of former versions of the diagrams named Unified Simulation Modeling Diagrams (USMD) or Unified Conceptual Modeling Diagrams (UCMD). USMD/UCMD on their turn were originally created from a mix of both ACDs [15] and RAD networks [11] and they can be used for modeling complex discrete event process problems from the domain classes of any of the study areas mentioned before [7].

Table I shows the ULMD symbols used in this work and their respective meaning, both in its former USMD/UCMD version and in its actual format. The actual format of the modeling notation resembles very much that of the basic set of Business Process Modeling Notation (BPMN) [16] icons

with a few extensions and one could question the need for “yet another type of process modeling notation or graphical diagrams”. In fact, BPMN is widely used and supported by large communities, becoming the “de facto” notation for creating models to be converted into specific proprietary notations and implemented in a variety of proprietary tools offered by different systems’ manufacturers. The use of the ULMD notation, however, is just a first step (the conceptual modeling phase) of a gradual modeling process and one can state that some semantic characteristics of ULMD are non-existent in any of the traditional graphical or textual process model representations, such as ACD, RAD, Workflows or even BPMN. These characteristics turn out to be essential for the type of logic and knowledge represented in the reference model.

TABLE I. ULMD: THE CONCEPTUAL MODELING NOTATION

Designation		Description
USMD / UCMD	ULMD	
		Starting point of the entity’s lifecycle process
		Finishing point of the entity’s lifecycle process
		Simple process/activity
		Macroprocess
	N/A	Queue of entities/resources waiting to enter an activity
	N/A	Queue of artifacts/messages waiting to enter an activity
		Link showing the control flow path carrying any type and number of entities and resources being transferred
		Link showing the control flow path carrying a specific artifact, message or triggering mechanism that needs to be distinguished
N/A		Links used for process synchronization
N/A		The crossing over the borders of the flow of control path carrying any type or number of entities and resources. The borders separate swimming lanes or frames and the symbols depict respectively the send and receive mechanisms
N/A		The crossing over the borders of the flow of control path carrying a specific artifact or message being transferred, which needs to be distinguished. The borders separate swimming lanes or frames and the symbols depict respectively the send and receive mechanisms
		Repositories of entities or resources
N/A		Connector used to direct the flow of control among processes to express routing at junctions (or exclusive, split and join)
N/A		Pads indicating the splitting or joining of paths associated with any type or number of entities, resources, artifacts or messages
N/A		Crossovers of entities or resources between two processes displayed in separate swimming lanes or frames

The ULMD distinctive features start with its high level of abstraction and minimalism, comprising only a dozen of different symbols for expressing the complete structural and dynamics of the agents’ lifecycles as concurrent processes. The diagram logic expresses all-in-one: the hierarchical process decomposition, the variety of agents and messages and their process control flows, the agents lifecycles or roles and the interactions among them. The diagrams are created in the form of encapsulated modules, which can be displaced in

frames or swimming lanes and pools, describing from a very simple process (task) to a very complex one (macroprocess).

Underlying all these characteristics, some of which could still be stated in regard to BPMN, there is an unequalled feature that differentiates ULMD from all other types of existing process modeling diagrams. They are not about pure logical operations and control flows (flowcharts), they are essentially about real time consuming transformation activities performed by real entities and messages (artifacts) exchanged between them. The links correspond to real entities flowing along their lifecycle (solid lines) or artifacts (dotted lines) exchanged between the activities, both used as inputs to other activities. Each class of entity has its specific process lifecycle, and they interact to perform their time consuming common activities, which get into a halt until all required inputs (entities and/or artifacts) are available and the additional internal initial conditions for their execution are satisfied. One special type of condition is external and it is depicted graphically, named triggering mechanism. The control flows are always associated with some type of entity, resource, artifact or triggering mechanism, and they reactivate the processes in a hold at a particular point in time and location, making it progress through its complete lifecycle.

III. THE T-PROST APPROACH

A T-ProST study is performed making use of a framework (T-ProST Framework), consisting of three elements, which constitute the pillars of the methodology: Knowledge Structure, made by the transdisciplinary hierarchical process model created (conceptual or reference model); Implementation Method, for their evolution along their respective lifecycles; and Supporting Tools, used to implement their integrated applications [7].

The Knowledge Structure consists of the hierarchical decomposition of the System’s Lifecycle (SL) process model in layers and is represented by the unified reference model. Each phase or macroprocess of T-ProST can be further decomposed into their component activities and single tasks, evidencing the gradual transformation of the System’s Lifecycle and, in particular, the simultaneous use of the diverse disciplines to build the multifaceted model on which the complete T-ProST study is carried out.

Table II presents the T-ProST approach described as macroprocesses and their respective component activities. The first column shows the Implementation Method or Unified Lifecycle Modeling procedure used to create the specialised models and evolve them along their lifecycles.









The macroprocesses or phases in Table II are designated:

- Phase Zero (Mission Definition/ Strategic Planning);
- Conceptual Modeling Phase (Analysis, comprising Elicitation/ IDEF0 Model/ Reference Model);
- Model Development Phase (Specialised Model Building/ Specialised Model Implementation);
- Model Execution Phase (Design of Experiments/ Experimentation);
- Finishing Phase (Specialised Assessment)
- Global Assessment (Integrated Joint Assessment);
- Holistic Revision

The Phase Zero consists in the system or problem definition and the identification of the study’s objectives, which is performed in one activity divided into two tasks, denominated Mission Definition and Strategic Planning, for generality purposes.

The second phase is the Conceptual Modeling Phase, to build the hierarchical process model in ULMD format, describing the operational processes, corresponding to the real transformations occurring in the system. This makes it easier for the different kinds of users and modelers to understand the system’s behavior, and later on to translate this model logic into their specific type of notations, in order to accomplish the specialised model building and construction phases.

TABLE II. T-PROST’S METHODOLOGY AND ITS USE IN SE

TRANSDISCIPLINARY PROCESS SCIENCE			
Unified Lifecycle Modelling	Phases	Activities	Tasks
	Zero	A0	Mission Definition and Strategic Planning
	Conceptual Modeling	Analysis (A)	Elicitation, IDEF0 Model, Reference Model
	Model Development	Specialised Model Building (B) Specialised Model Construction/ Implementation (C)	B1, B2,B3, B4 C1, C2, C3, C4
	Model Execution	Design of Experiments (D) Experimentation (E)	D1, D2, D3, D4 E1, E2, E3, E4
	Finishing	Finishing (F)	F1, F2, F3, F4
	Global Assessment	General Assessment (G)	General Assessment
	Holistic Revision	Holistic Revision (H)	Holistic Revision
			

The remaining phases are those shown in Table II with their respective denomination and more detailed definition given by the decomposition of its respective macroprocess into its components, consisting of composed or single activities, the last ones named tasks. The four types of Tasks B, C, D, E and F are those related with the four component disciplines of T-ProST (SE, PM, BPM and SIM). They are treated separately during the phases of Model Development, Execution and Finishing (specialised modeling, execution and evaluation), and their results are integrated in the Global Assessment Phase, to yield a thorough assessment of the multifaceted model created making use of the transdisciplinary reference model.

The Implementation Method or Unified Modeling of the System's Lifecycle Process is created by the aggregation of the different worldviews used by the individual disciplines that are part of T-ProST. These disciplines are jointly applied making use of a reference model as a common basis for the uniformization of the system's description, representative of its essential structural and dynamical features. The implementation method comprehends the transformation of the reference model into the specialised models, their implementation, execution, analysis and assesment, initially as units, and later on as aggregate, yielding a complete multidimensional analysis of the system, based on a holistic view that encompasses all individual disciplines applied.

The models are created gradually in the form of layers, the most internal one depicting the transformations associated with the systems engineering process (SE model), followed by the PM model that encompasses and extends these operational processes with those necessary for project management.

The BPM model is built on the top of the PM model and extends it with additional processes, whenever necessary, as for example with the management processes related with the coordination of a portfolio of projects. This gradual modeling and implementation procedure is performed until the outermost layer is built, consisting of all processes associated with the core product development processes, the project management processes and the complementary business management processes by the organization, encompassing its complete product lifecycle. Any of the intermediary single layers can be treated separately and used for analysis purposes, in the traditional way their studies are performed. Simulation as a tool can also be used in association with any of the individual layers across the whole modeling procedure. The denomination of SIM model, however, is reserved for the outermost layer describing the complete SL, which comprises the BPM model, with its internal PM and SE layers, and any the additional features necessary to conduct a complete simulation study of the System of Interest (SoI), be it the Product Lifecycle (PL) or the Enterprise Lifecycle (EL), according to the objectives of the study.

IV. PROBLEM DEFINITION

To conduct the actual case study on the application of the T-ProST approach in the SE's design phase process in this work, one decided to use a modified version of the System Engineering Body of Knowledge (SEBoK) [3] reference model of the domain of interest, that is, the design phase of the SE Project. Before going into details about the Product Lifecycle Modeling (PLM) model, though, it is useful to establish the broad scope of the BPM model making use of the APQC's Process Classification Framework (PCF) [1] to illustrate the complete organization EL reference model.

Figure 1 illustrates the scopes in which the concepts System Lifecycle (Enterprise Lifecycle or Product Lifecycle) and their respective Reference Models are used in this work. The EL reference model is based on a top-down view of the organization, describing it according to a holistic process view, encompassing all EL phases, from strategic vision through product development, deployment, operation and the client management, until final product disposal. In this

context, PL and PLM are considered a part of the EL and BPM, as indicated by part 2.0 of APQC's PCF [1], which shows the macro Develop and Manage Products and Services, comprising the product's engineering and management processes.

Part 2.0 of APQC's PCF [1] presents no detailed description about how these generic processes should look like, apparently because they are left to be defined by each specialised type of industry.

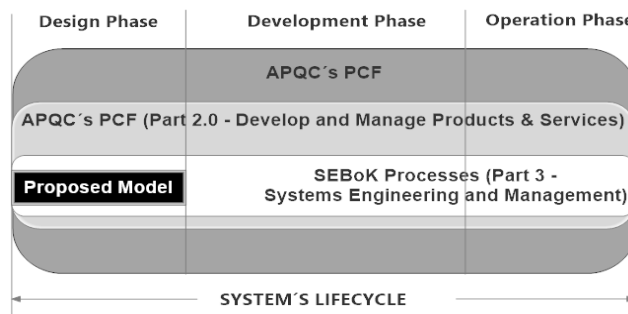

Figure 1. Scopes of APQC's PCF and SEBoK SE's design phase reference models

In the case study presented here this part of the modeling was based on the reference model presented and described in detail in part 3 of the SEBoK [3] and illustrated in Figure 2.

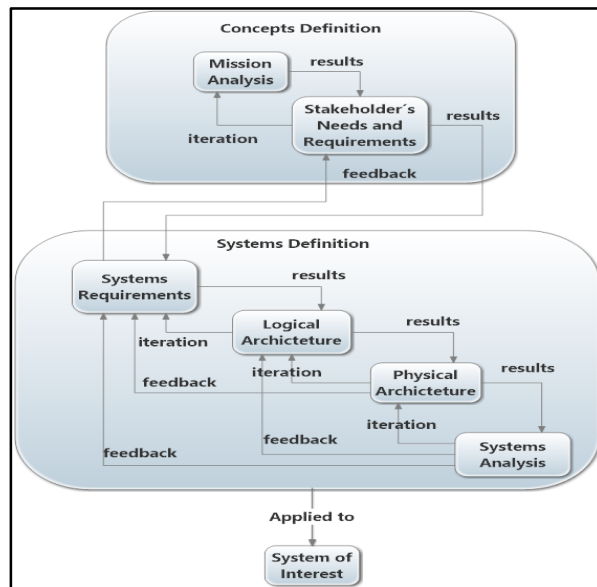

Figure 2. SEBoK [5] SE's design phase process modified by authors Conceptual Modeling

Any enterprise that has SE as the main driver of its production processes may well make use of the PL and PLM concepts definitions in SEBoK [3] to describe their product's design phase according the reference model mentioned above.

The T-PROST approach is demonstrated in the following in a stepwise way, by applying it to the problem described above, according to implementation method shown in column one of Table II.

V. CONCEPTUAL MODELING

The Conceptual Modeling Phase is carried out through an activity denominated Analysis, which consists of three tasks, the first and second ones concerned with the description of the process hierarchical structure (descriptive model), and the third one concerned with its dynamical description (process model).

The descriptive model makes use of techniques typical of the SE worldview: the Elicitation of Information on the process; and the creation of the Integrated DEFINition for function modeling diagrams (IDEF0) [6] to create the IDEF0 model, for process decomposition and documentation. The descriptive model consists in the detailed hierarchical description of the PL in the IDEF0 format. The IDEF0 model comprises all available information on the processes (inputs, outputs, control and resources), except for the workflow of process execution. Figure 3 shows the internal decomposition of the macroprocesses Concepts Definition and Systems Definition in the IDEF0 notation.

The third task of the Conceptual Modeling Phase is typical of the SIM worldview: the Creation of the Reference Model, a process model based on the descriptive model and the addition of the sequence of execution or workflow of

processes. The workflow for process execution is added at this stage of the unified model development lifecycle, making use of the ULMD notation. Despite resorting to mechanisms typical of the SE and SIM worldviews for its elaboration, the reference model created describes the process logic in a very abstract way, which is independent of the specific representations existing in the individual disciplines that are part of T-ProST.

The ULMD reference model of the systems engineering design phase is shown in Figure 4. Two types of loops are used to describe the iterations, which need to be executed in case it is necessary to perform revisions of the work previously accomplished, denominated FB1 and FB2, according to the following definitions:

- FB1 – Iteration: loop for minor revision, between two consecutive processes, belonging to the same macroprocess or phase of a Project.
- FB2 – Feedback: loop between two non consecutive processes, which might belong to a single macroprocess or different ones, for reworking an outcome that should have already been produced in previous stages of the entitie’s lifecycle, but which needs to be redefined or to suffer a major revision.

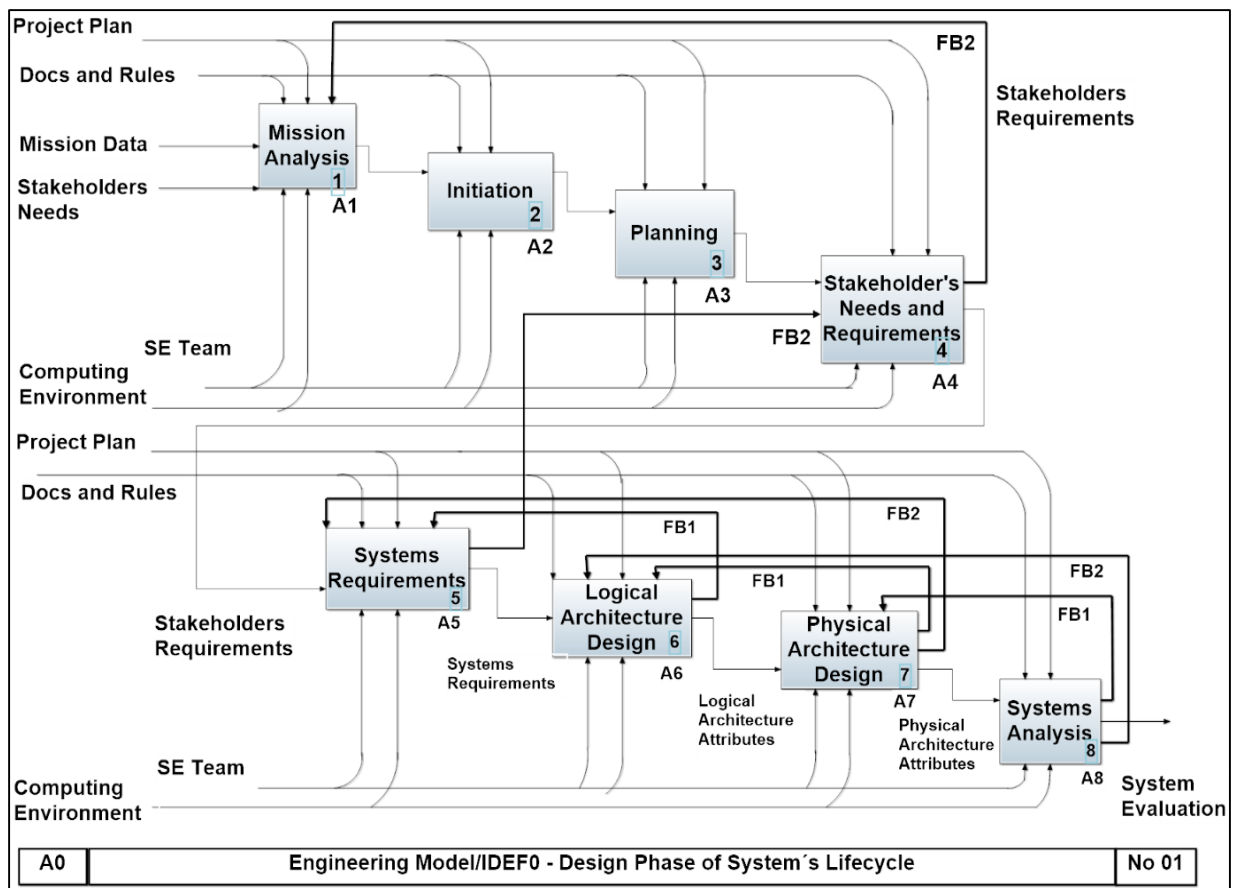

Figure 3. SE’s design phase – concepts definition and systems definition – in IDEF0

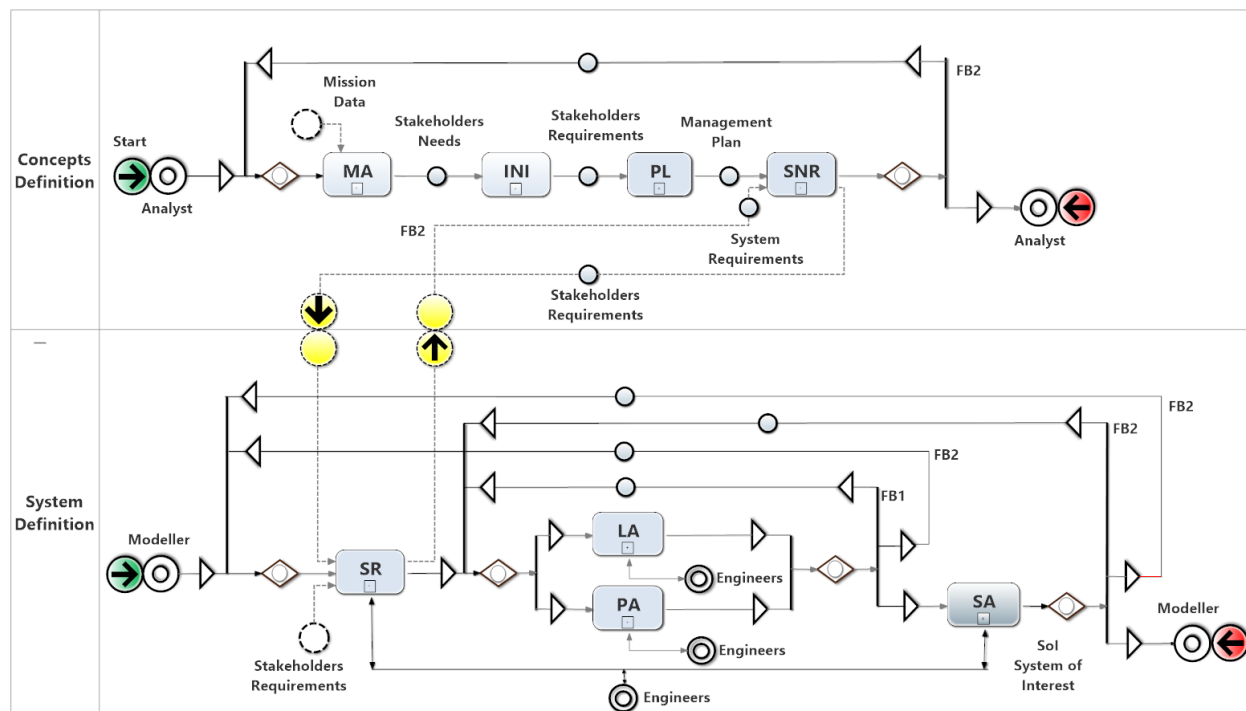

Figure 4. SE design phase – concepts definition and system definition – in ULMD

The macroprocesses Concept Definition and System Definition might undergo successive iterations, during the execution of the systems engineering lifecycle design phase, and the processes might be executed by just one class type of entity or by different types, each class type responsible for a specific process, for example, mission analysts and system modelers. The agents responsible for the execution will act sequentially or in parallel, according to the execution flow previously defined or that established at runtime by means of the scripts used in the activities for routing the control flow during model execution. This is assured by drawing the diagrams as sequential processes only if this is mandatory, otherwise they are displayed as parallel and their execution might occur simultaneously, if there are enough resources available, or they might be executed sequentially, if the conditions and internal limitations make it necessary. A loop encompassing the processes whose sequential or parallel execution is not determined beforehand enforces that all of them are correctly performed before the control flow is passed ahead to the next process in the entity's lifecycle.

VI. SPECIALISED MODEL BUILDING AND ANALYSIS

The Model Development phase is performed according to each of specialised modeling and analysis techniques originated from the autonomous disciplines component of T-ProST.

The transformation of the Reference Model into the specialised models with their supporting applications can be used as a basic PLM environment, if the software tools used possess all the management features required for documenting, monitoring and controlling product's configuration and its evolution along the entire product's

development lifecycle, from conception to disposal. The first steps performed by the SE Modeling tasks B1 and C1 in Table II are just the start for the creation of a more complete and integrated environment. This complete environment will be formed by the addition of the tools created through tasks B2 and C2 in the PM Modeling activity, those created through tasks B3 and C3 in the BPM Modeling activity, as well as those created through the tasks B4 and C4, in the Simulation Modeling activity. All these tools have a complementary nature, resulting from the fact that they all make use of the same reference model and adopt a systematic approach for their implementation, as described below, in the following steps of the application of the T-ProST Framework.

A. SE Modeling

The Systems Engineering Modeling consists in the transformation of the Reference Model into the specialised SE model. This corresponds to thoroughly documenting the model, starting with the known knowledge content about the Reference Model, that is, a merge of the information shown in Figure 3 and Figure 4. The SE modeling might be supported by databases applications and also by some kind of configuration and control management system, ideally one that can display, both graphically and as linked data, the complete information on the model, including the process model hierarchical decomposition and execution sequence, for monitoring purposes.

The documentation of the case study presented in this work required keeping track of all data related to the product design phases (Concepts Definition and Systems Definition), as well as the addition of more model documentation, such as the descriptions of the artifacts created by the SE processes.

B. PM Modeling

The objective of the PM study area is to plan and coordinate the activities necessary to provide a satisfactory product, service or enterprise’s endeavour, within the boundaries set by the chronogram, the budget, resources, infrastructure and human resources and technology available.

The traditional way to describe a project is by representing it as a sequenced network of activities, by means of diagrams

known as Program Evaluation and Review Technique (PERT) [18], a renowned and well documented technique, used for management of engineering projects, be it of a service or industrial nature, aiming at their planning and execution control. This would result at a macroprocess level in the diagram depicted in Figure 5.

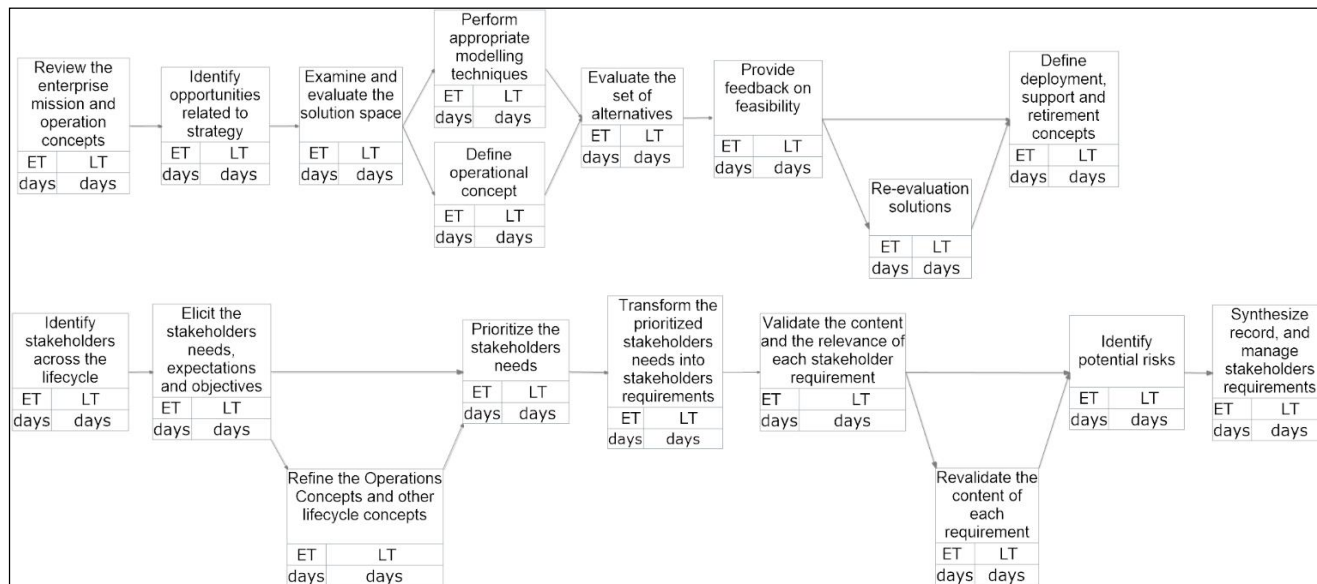

Figure 5. Concepts definition process – PERT model

PM modeling is seen as the application of PM techniques making use of a process oriented worldview supported by software tools to extend the SE model with the necessary activities related with the management of product development along the entire product lifecycle. The PM model extends the SE process model with additional PM processes and explains all relations between these two types of models [7].

By using the T-ProST approach, one can get great gains by addressing PM not just for the management of a single project, but for the management of multi-projects, through process modeling and the integration of the concepts and methodologies used in PM, BPM and SIM. Traditionally, the PM, BPM and SIM methodologies and their supporting tools have remained conceptually very divergent and self-contained in their respective knowledge and application domains, showing little communication between them, due to this “single enterprise” way of handling projects in the PM study area.

On the one hand, project management concepts, such as critical paths and completion time for a segment of the process, typical of PM, can be applied in simulation studies to yield greater productivity and a thorougher analysis of possible strategies for system operation. On the other hand,

simulation modeling concepts, such as idle times of entities staying in queues in front of activities and dynamical resources allocation, can be applied to reduce segments or overall process completion times and costs in PM applications in the SE lifecycle.

C. BPM Modeling

BPM is a structured and systematic approach for conducting modeling, analysis, automatic execution and control, management and continuous improvement of processes used in the product engineering and production management of complex product and services [10][14].

Figure 6 shows the design phase of the systems engineering lifecycle in the BPMN notation [16]. This is just the first step of the modeling process, the model representation using the Bizagi’s Process Modeler [2]. The complete modeling procedure needs a second modeling step, making use of the Bizagi suite, an environment where this initial graphical model can be extended with many additional features and transformed into running applications, which may be used for automating some features of the system’s operational process. The complete set of software tools to support the BPM methodology is known as Business Process Management Systems (BPMS) [10].

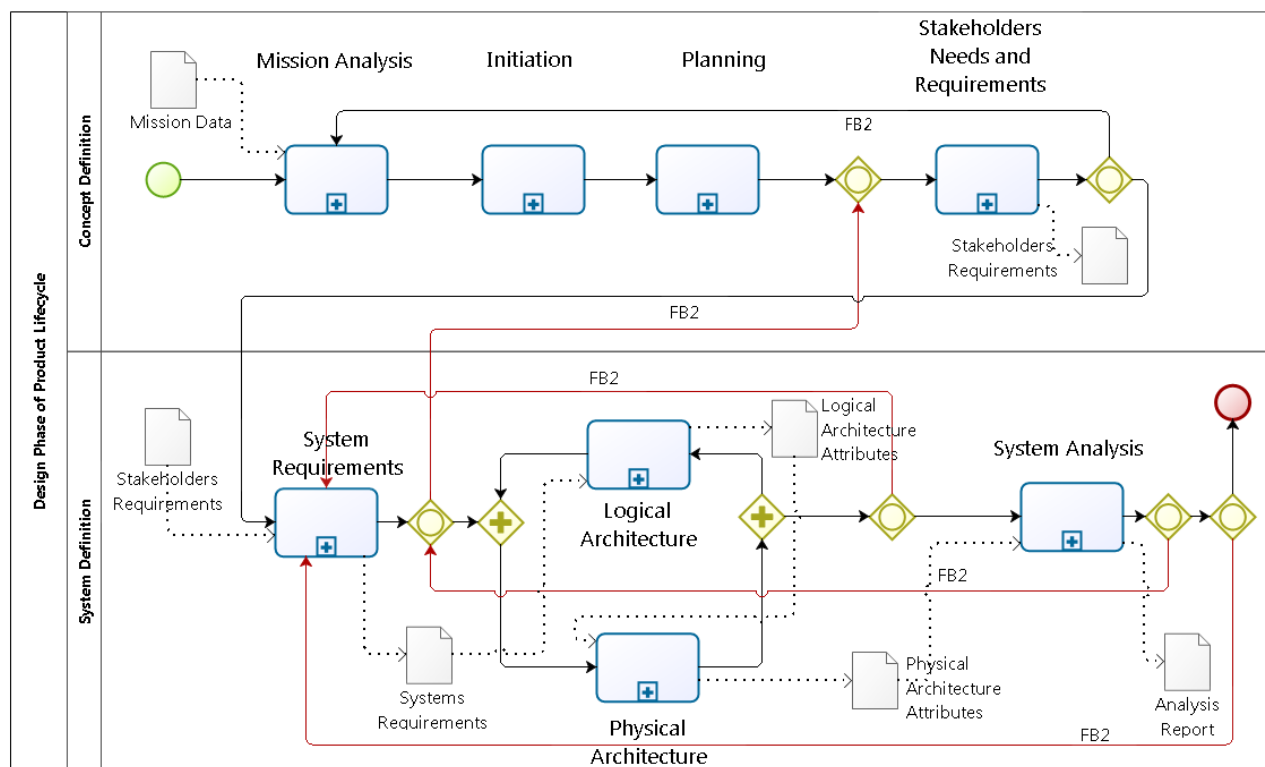

Figure 6. SE's design phase – concepts definition and systems definition – BPMN model

The BPMS tools work throughout the complete model life cycle of business processes studies: modeling, implementation, execution, automation, monitoring, analysis and continuous improvement of the system. They provide an environment for the complete development and deployment of an application that will act as part of the mechanisms used in the operation of the real system, playing a major role in aspects regarding its execution, its monitoring and control, and contributing for its continuous improvement.

The organizations, however, still face a complex scenario for customizing and improving their business processes due to the diversity, incompatibility and/or incompleteness of methods, as well as the high costs of deployment of its supporting tools. The T-ProST general systematic approach could help to integrate and unify concepts and tools used in support of SE, PLM, PM and BPM and to help discard some overhead results that might turn out to be inconsistent, duplicate or superfluous regarding these existing individual study areas. The use of BPMS systems can provide the means for implementation of automated procedures to conduct the operation of the real system. Other main applications to compose the T-ProST supporting environment might be chosen among existing tools as well, and additional interfaces might be built for their integration

D. Simulation Modeling

The use of SIM in T-ProST follows the traditional definition of simulation with the remark that one is addressing the aggregate of the processes representative of the systems

engineering and of the organization management lifecycles [7].

The complete simulation application requires the creation of the facilities needed for the experimentation (design of experiments) and of any other additional features for analysis and presentation of results.

Model assessment in simulation studies can be made by a combination of the normal procedures used in simulation for this purpose with the techniques derived from project management of a multi-project nature, with the aim of enhancing the understanding of the experimental factors and strategies which significantly affect system's productivity.

The integrated use of standard model assessment and project management techniques in simulation studies reveals that they have a complementary nature, the first group of procedures allowing for the analysis of the dynamics of the process, including optimization of resources allocation, and the second one allowing for a better evaluation of activities completion time of partial or complete production cycles, as well as their cost assessment.

The only special feature is the use of the SL reference model, represented in the ULMD notation, to base model development in the proprietary simulation system offered by the different manufacturers. The reference model is transformed into the specific model notation and implemented according to the manufacturers of the proprietary systems, as shown in the example of Figure 7, created with the SIMPROCESS simulation system [5].

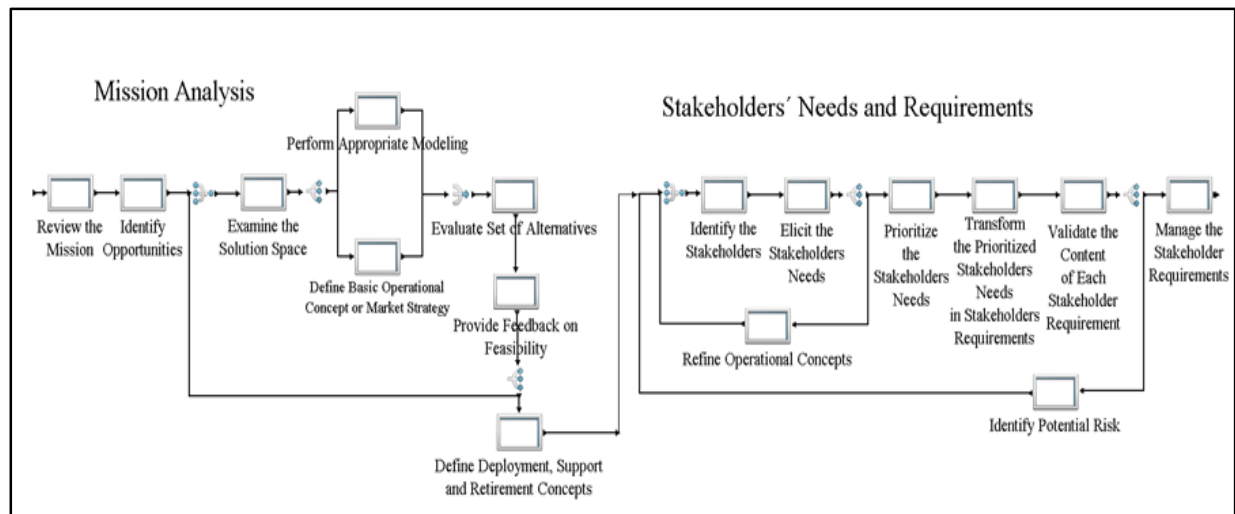

Figure 7. SE'S design phase - concepts definition macroprocess – simprocess model

The application of the existing software tools interchangeably in each of these study areas can already improve the simulation model assessment and the multi-projects management tasks. The combination of these two techniques is therefore very promising, but its advantages cannot be entirely exploited through the separate use of the actual existing software tools of the individual types in studies of the other area, because they have been designed with different purposes, which do not take into account their complementary nature.

VII. GLOBAL ASSESSMENT

T-ProST presents an interesting alternative way to improve the solution of problems involving complex business processes, that is, instead of making use of the existing knowledge base to create new techniques and tools, and/or to improve the already existing ones, one would focus on the (re)structuring, integrating and unifying the knowledge base underlying them.

This holistic approach could consolidate all the scattered knowledge on complex process under a single umbrella, capable of covering the entire problem domain and covering the complete process model life cycle. This innovative holistic view addresses both the restructuring of the knowledge content (descriptive view) and the creation of a general systematic modeling procedure (unified process view), making use of reference models to base the individual or combined use of the diverse modeling techniques to create multifaceted models.

The objective is to progress towards the integration and the unification of the concepts, methods and tools from these diverse techniques, seeking to apply them simultaneously in an easy and consistent way, thereby achieving the same complementary benefits from their individual use and, at the same time, avoiding any overheads, inconsistencies and duplications related with their joint application.

The proposed methodology can be applied to a large problem class, with special interest focused on applications in

serial processes and in multi-projects of an identical single project nature, whose execution share common resources and occur in parallel.

The full development and application of the methodology will require the use of existing tools to perform several case studies, as well as the creation of a new hybrid environment, which on its turn will require quite a lot of software application and development time. For the moment, one has already performed studies making use of the following support tools: ProjectLibre [17], to support project management applications; Bizagi [2] and Bonita [4], to support the application of BPM techniques; and Simprocess [5], to build simulation models and conduct their analysis of results. The main reason for choosing these tools was their availability in the form of open source or low cost academic licenses. They can be easily substituted by similar systems, since the great majority of them can cope with the implementation of the specialised models described in the SE, PM, BPM and SIM categories presented in this work.

There is an expected overhead in this attempt to apply a transdisciplinary approach based on existing autonomous tools, represented by the expensive procedure in regard to maintaining model consistency and compatibility across the whole model development life cycle. This overhead resulting from the application of a unified approach right from the start of the modeling process is seen rather as an anticipation of future problems, which might remain unsolved if the traditional way, based on independent application of the techniques and the gathering and interpretation of their results to build a global solution thereafter, is applied. This drawback can be reduced in future studies of this kind by the use of formal verification procedures and of software mechanisms to improve process model consistency and compatibility.

The authors advocate further that a more encompassing and definitive solution for this problem can be achieved through the evolution of the T-ProST Framework and the improvement of its supporting tools, aiming at its transformation into a mature methodology. The foundations

and guidelines for implementation of this methodology have been presented in this work and they will be pursued and extended in future research.

VIII. HOLISTIC REVIEW AND CONCLUSIONS

The application domain of the T-ProST approach comprises not only the Product's Lifecycle (PL) processes with its development and management processes (known as PLM in the literature), but also the Enterprise's Lifecycle (EL) process, with its business process management procedures (known as BPM in the literature). The complete holistic view on processes advocated by the T-ProST approach considers PLM as a part of BPM, and refers to product's and enterprise's lifecycles simply as System's Lifecycle (SL), with the meaning of the *system* concept made clear by the context in which it appears.

The USMD/UCMD former versions of the notation have been used to describe and conduct some case studies on a variety of discrete event problems, such as a steelworks problem used as a class project, which is an example of a serial production process, typical of the SIM study area. Another example of application was on a house construction process, typical of the PM study area, which has been modeled and studied as a hybrid PM and SIM problem, showing the diversity of systems that can be represented using the notation.

The present work improves the experience obtained in those previous case studies and presents T-ProST as an aggregate of the application of the individual techniques. The multifaceted modeling makes use of a reference model of the design phase processes of the systems engineering lifecycle as a common basis, aiming at the integration and the exploitation of their complimentary advantages. As a result, the T-ProST framework has been revised, which will lead to the development of a mature methodology and its supporting tools for application in additional case studies in the future, for continuous improvement of the methodology and its supporting environment.

The full benefits of a unified methodology shall only be achieved if one undertakes the design and the construction of a hybrid environment to deal simultaneously with all the issues involved in the individual study areas. A hybrid environment based on an integrated approach will allow the modeling and analysis of a production process as the application of basic SE, PM, BPM and SIM tools, in substitution of complex PLM systems, which are costly and difficult to customize, and therefore not adequate for SME. With such tools it will be possible to increase productivity, reducing segment or full process completion time, subjected to resources and costs constraints, by shifting and analysing the start of successive production cycles, for example.

ACKNOWLEDGMENTS

The authors acknowledge the MSc and PhD research students who participated in the courses CSE-326 and CSE-331 year 2015 of the Post-Graduation Program ETE/INPE, who participated in the development and implementation of the system engineering design phase models, as class projects.

REFERENCES

- [1] American Productivity and Quality Center. Process classification framework. [Online]. Available from: <https://www.apqc.org/pcf> 2015.10.15
- [2] Bizagi. BPM suite overview. [Online]. Available from: <http://www.bizagi.com/en/bpm-suite> 2015.10.15
- [3] Bkcase Editorial Board. The guide to the systems engineering body of knowledge (SEBoK), v. 1.4. R. D. Adcock (EIC). Hoboken, NJ: The Trustees of the Stevens Institute of Technology, June 2015. [Online]. Available from: http://sebokwiki.org/wiki/Download_SEBoK_PDF 2015.10.15
- [4] Bonita BPM 7.1.2. Community Edition. [Online]. Available from: <http://www.bonitasoft.com/products-v2#versions-community/2015.10.23>.
- [5] Caci Inc. Federal. Simprocess - Product overview and user's manual. Release 5.2. [Online]. Available from: <http://simprocess.com/about-simprocess/simprocess-documentation/> 2015.10.15
- [6] Federal Information Processing Standards Publications (FIPS PUBS). Integration Definition for Function Modeling (IDEF0). [Online]. Available from: <http://www.idef.com/pdf/idef0.pdf> 2015.10.10
- [7] G. S. Kienbaum, A framework for process science and technology and its application to systems concurrent engineering. São José dos Campos: INPE, Technical Report. [Online]. Available from: <http://urlib.net/8JMKD3MGP3W34P/3KG6NB5> 2015-10-29.
- [8] G. S. Kienbaum, "A framework for process science and technology applied to concurrent engineering", In: ISPE International Conference on Concurrent Engineering, 19., 2012, Trier, Germany. Proceedings... London: Springer-Verlag, 2012. v. 2, p. 1033-1044. ISBN 9781447144250. [Online]. Available from: <http://plutao.sid.inpe.br/col/dpi.inpe.br/plutao/2012/11.28.14.40.58/doc/CE2012.pdf>
- [9] International Council On Systems Engineering. Systems engineering handbook: a guide for system lifecycle processes and activities. 4th Edition. Hoboken, NJ, John Wiley & Sons, 2015.
- [10] J. Jeston and J. Nelis, Business process management: practical guidelines to successful implementations, Oxford: Butterworth-Heinemann, 2008.
- [11] J. Murdoch and J. McDermid, "Modelling engineering design processes with role activity diagrams", In: Transactions of the SDPS, Vol. 4, No. 2, June 2000, pp.45-65.
- [12] L. A. Silva, G.S. Kienbaum, G. Loureiro and M. M. Tanik, "A design and process science study applied to the Laboratory for Integration and Testing of the National Space Research Institute (LIT/INPE)," In: SDPS 2011. 2011, Jeju Island South Korea. Proceedings... [Online]. Available from: <http://plutao.sid.inpe.br/col/dpi.inpe.br/plutao/2011/06.11.14.52/doc/SDPS2011.pdf>.
- [13] NASA. Systems engineering handbook. 2007. [Online]. Available from: <http://ntrs.nasa.gov/> 2015.10.10
- [14] N. Melão and M. Pidd, "A conceptual framework for understanding business processes and business process modelling", In: Information Systems Journal, 2000, pp. 105-129.
- [15] M. Pidd, Computer simulation in management science, 3rd Edition. John Wiley & Sons, Chichester, UK, 1992.
- [16] Object Management Group. Business process modeling notation – V. 2.0. OMG Document Number: formal/2011-01-03. [Online]. Available from: <http://www.omg.org/spec/BPMN/2.0/> 2015.10.10
- [17] ProjectLibre User Guide - Version 0.3.3. [Online]. Available from: <http://www.projectlibre.org/> 2015.10.23.
- [18] Project Management Institute. A guide to the project management body of knowledge, 5th ed. Newtown Square, PA: Project Management Institute, 2013.
- [19] W. Van der Aalst, M. Weske and G. Wirtz, "Advanced Topics in Workflow Management: Issues, Requirements and Solutions", In: Transactions of the SDPS, Vol. 7, No. 1, 2003, pp. 49-77